

DEEP CYCLE MARINE BATTERY



BB12120FM 12V120Ah

Specifications

Nominal Voltage		12V
Rated capacity (10 hour rate)		120Ah
Dimensions	Length	408± 2mm(16.06inch)
	Width	172± 2mm(6.77inch)
	Height	235± 2mm(9.25inch)
	Total Height	235± 2mm(9.25inch)
Approx. Weight		24kg(52.9lbs)± 3%



Outer dimensions (mm)

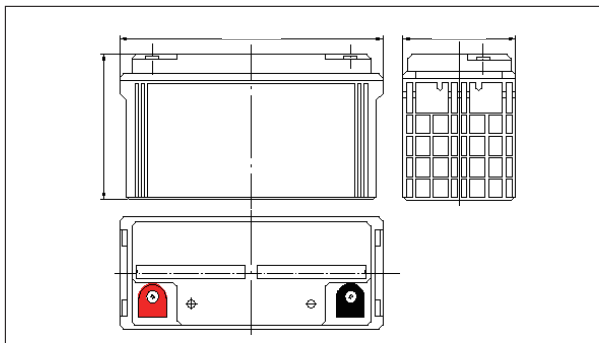

Terminal Type (mm)

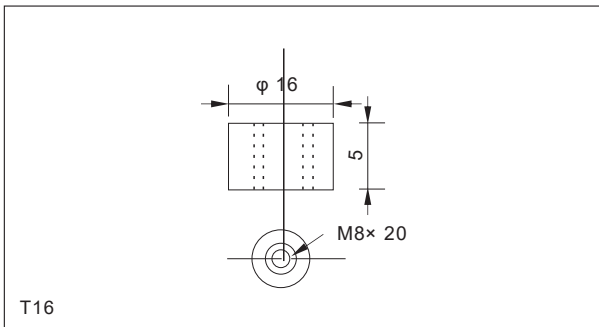

Characteristics

Capacity (25°C)	10HR(10.8V)	120Ah
	3HR(10.8V)	90Ah
	1HR(10.5V)	66Ah
Terminal type		T16
Internal resistance (Fully charged, 25°C)		Approx. 4.5m Ω
Capacity affected by temperature (10HR)	40°C	102%
	25°C	100%
	0°C	85%
	-15°C	65%
Self-discharge (25°C)	3 months	Remaining Capacity:91%
	6 months	Remaining Capacity:82%
	12 months	Remaining Capacity:65%
Nominal operating temperature		25°C ± 3°C (77°F ± 5°F)
Operating temperature range	Discharge	-15°C~50°C(5°F~122°F)
	Charge	-10°C~50°C(14°F~122°F)
	Storage	-20°C~50°C(-4°F~122°F)
Float charging voltage(25°C)		13.50 to 13.80V Temperature compensation: -18mV/°C
Cyclic charging voltage(25°C)		14.40 to 14.70V Temperature compensation: -30mV/°C
Maximum charging current		24A
Maximum discharge current		950A(5 sec.)
Designed floating life(20°C)		10years

Construction

Component	Positive plate	Negative plate	Container	Cover	Separator	Electrolyte	Safety valve	Terminal
Raw material	Lead dioxide	Lead	ABS	ABS	AGM	Gel	Rubber	Copper

Constant Current Discharge Characteristics Unit:A(25 °C, 77°F)

F.V/Time	10min	15min	30min	60min	2h	3h	4h	5h	8h	10h	20h
9.60V	234	192	116	72.0	43.8	31.2	24.5	20.8	14.7	12.2	6.47
9.90V	227	187	114	70.9	43.6	31.0	24.3	20.7	14.6	12.2	6.46
10.2V	218	180	111	69.1	43.2	30.8	24.2	20.5	14.5	12.2	6.44
10.5V	208	174	108	67.0	42.6	30.6	24.0	20.4	14.4	12.1	6.40
10.8V	197	165	104	64.8	41.5	30.0	23.3	19.8	14.0	12.0	6.36

Constant Power Discharge Characteristics Unit:W(25 °C, 77°F)

F.V/Time	10min	15min	30min	60min	2h	3h	4h	5h	8h	10h	20h
9.60V	2527	2108	1306	821	508	367	288	246	174	146	77.7
9.90V	2451	2058	1280	808	505	365	286	245	173	146	77.5
10.2V	2350	1982	1241	788	500	362	284	243	172	145	77.3
10.5V	2249	1914	1211	763	493	360	282	241	171	144	76.9
10.8V	2123	1813	1166	739	480	353	274	234	166	143	76.3

Note: The above characteristics data can be obtained within three charge or discharge cycles.

BB12120FM 12V120Ah

Discharge characteristics(25°C)

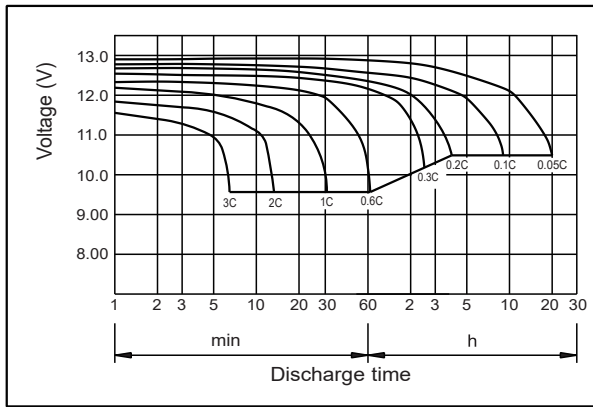

Charging characteristics (25°C)

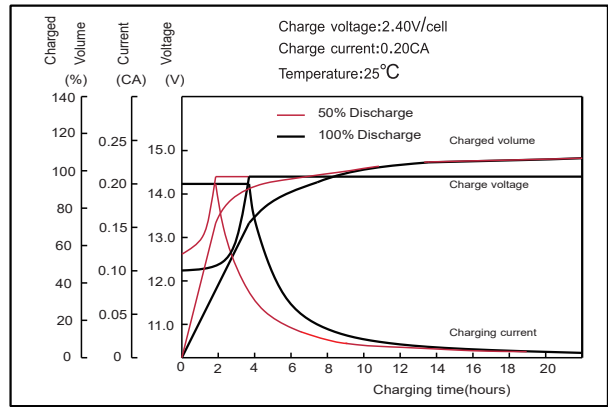

Temperature effects on Capacity

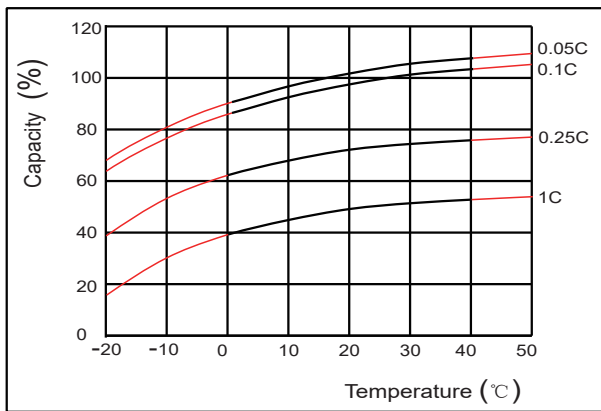

Self-discharge characteristics

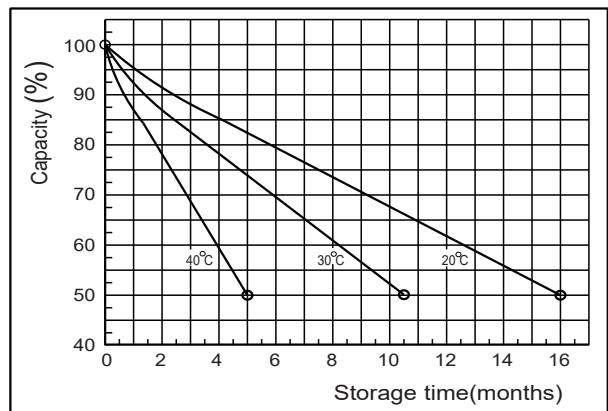

Floating life on Temperature

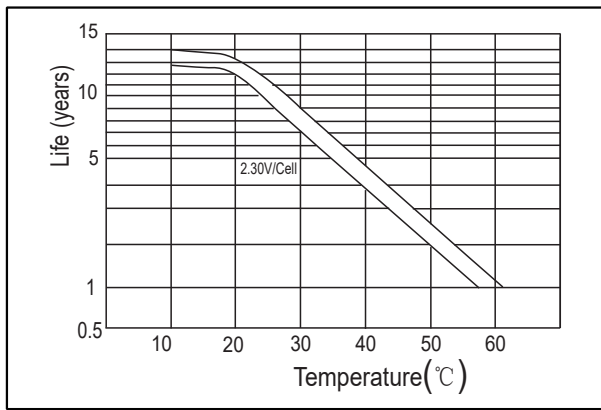

Cycle life on D.O.D (25 °C)

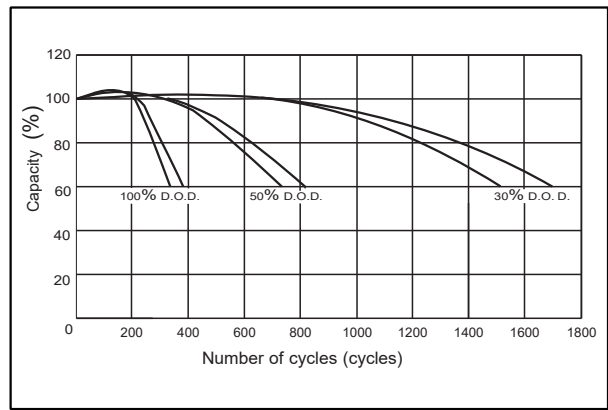

The relationship for OCV and Capacity (25°C)

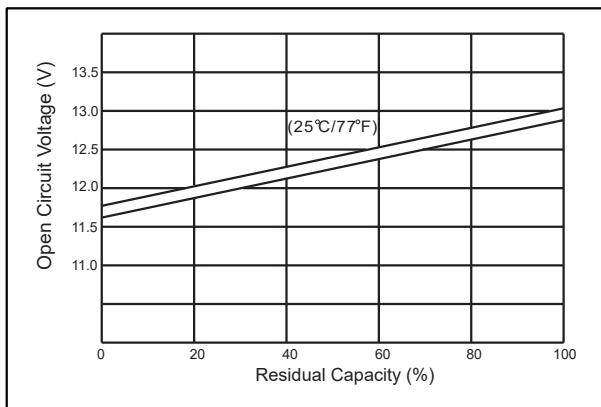

The relationship for Charging voltage and Temperature

